

# Features

## DIN Rail Series

- Universal AC Input (85-264VAC)
- Protections: SCP, OVP, OLP, OTP
- DC OK Indicator LED with Relay Contacts
- 150% (180W) peak load capacity
- Built-in active PFC, PF>0,95
- High efficiency up to 92.5%

## REDIN120

### 120 Watt DIN-Rail Power Supply



### Description

These DIN-rail mounted power supplies have a robust case, 4mm screw terminal connectors and use high reliability components to give a long, trouble-free life. The REDIN120 can be end mounted to save rail space or side mounted for use in low-profile cabinets. The units can deliver up to 150% start-up power and allow n+1 parallel operation to increase the continuous output current or for supply redundancy. Relay contacts simplify DC OK monitoring. The REDIN120 series is designed for demanding commercial and industrial applications with UL508, UL60950, IEC60950 CB report and CE (LVD + EMC + RoHS) certifications. They come with a full 5-year warranty.

### Selection Guide

Part Number	nom. Input Voltage Range [VAC]	Output Voltage [VDC]	Output Adjustability [VDC]	Rated Current [A]	Efficiency typ. 230VAC full load [%]
REDIN120-12	100-240	12	12-14	8.33	89.5
REDIN120-24	100-240	24	24-28	5	91.5
REDIN120-48	100-240	48	48-56	2.5	92.5

### Specifications (measured @ ta= 25°C, rated Vin, rated load and after warm up)

BASIC CHARACTERISTICS					
Parameter	Condition	Min.	Typ.	Max.	
Input Voltage Range		85VAC		264VAC	
Absolute Maximum Input Voltage	max. 3s			300VAC 375VDC	
Input Current	115VAC, full load 230VAC, full load			1.5A 0.65A	
Return Voltage Immunity	12Vout 24Vout 48Vout		18V 35V 65V		
Inrush Current	115VAC, cold start 230VAC, cold start		40A 60A		
No Load Power Consumption	115VAC 230VAC		1.5W 1.2W	3W 3W	
Input Frequency Range		47Hz		63Hz	
Output Voltage Trimming				+16.67%	
Power Factor	115VAC 230VAC		0.99 0.95		
Start-up time	115VAC, full load 230VAC, full load			500ms 250ms	
Hold-up time	115VAC, full load 230VAC, full load	20ms 20ms	40ms 40ms		
Ripple and Noise <sup>(1)</sup>	0 - 70°C -25°C	12Vout			100mVp-p 200mVp-p
	0 - 70°C -25°C	24Vout			120mVp-p 240mVp-p
	-25°C - 70°C	48Vout			240mVp-p

#### Notes:

Note1: Measured at 20MHz bandwidth by using a 12" twisted pair-wire terminated with a 0.1µF & 10µF parallel capacitor.

continued on next page



UL60950-1 Certified  
UL508 Certified  
IEC/EN60950-1 Certified

Specifications (measured @  $t_a = 25^\circ\text{C}$ , rated  $V_{in}$ , rated load and after warm up)

## REDIN120-12

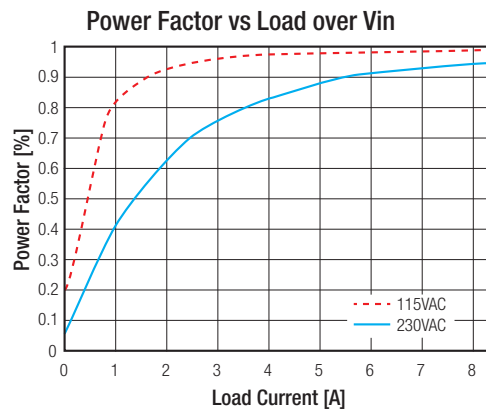
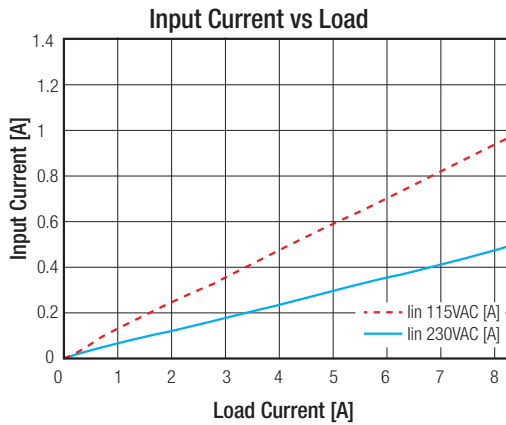
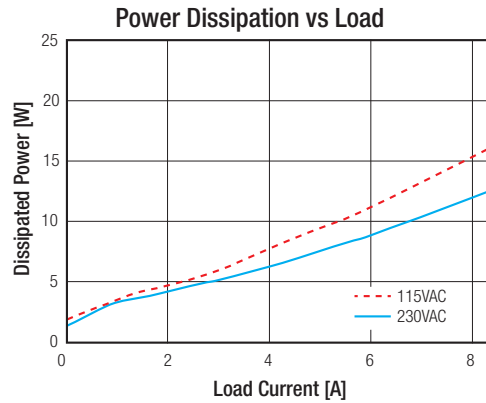
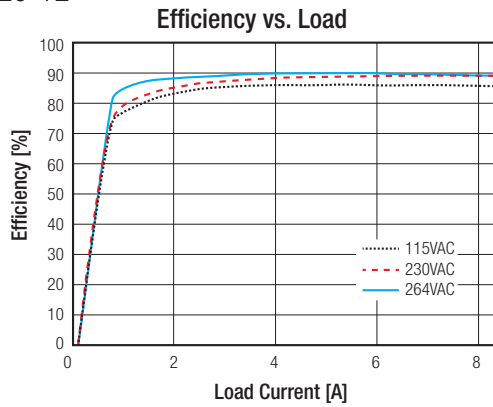

## REDIN120-24

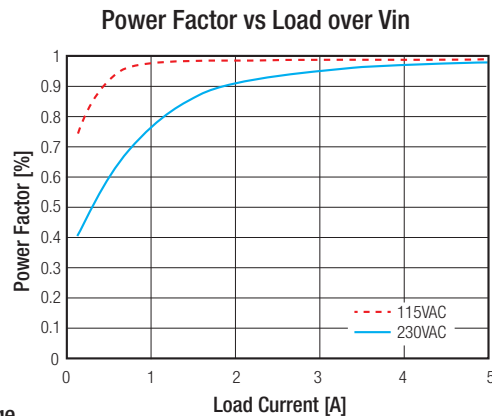
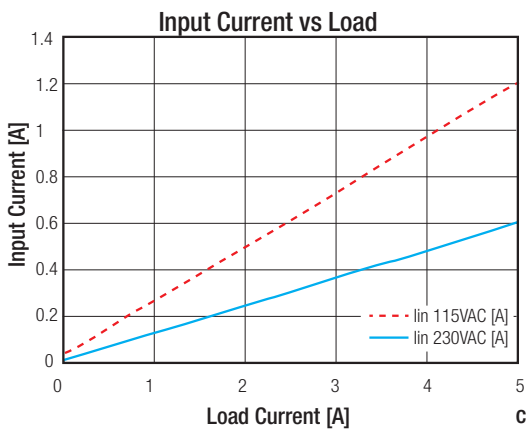
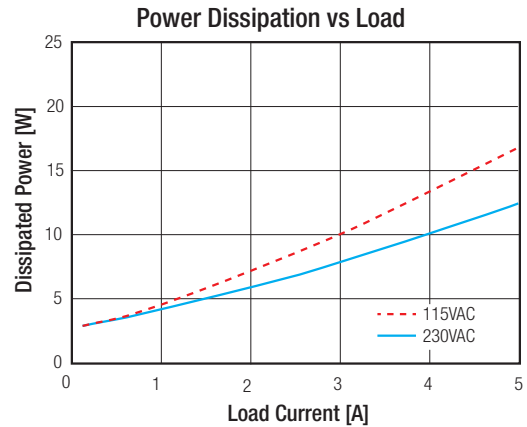
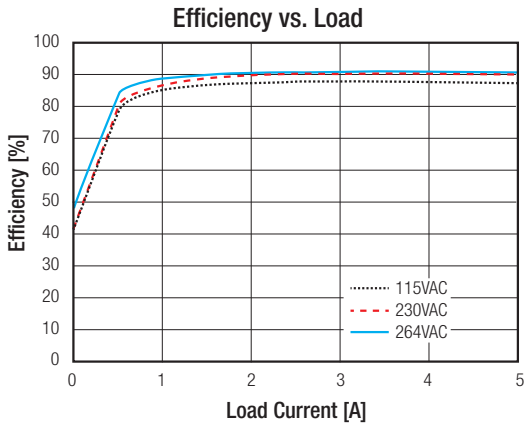

continued on next page

Specifications (measured @  $t_a=25^\circ\text{C}$ , rated  $V_{in}$ , rated load and after warm up)

REDIN120-48

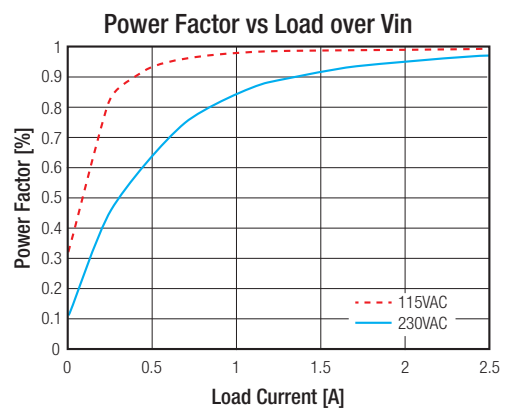
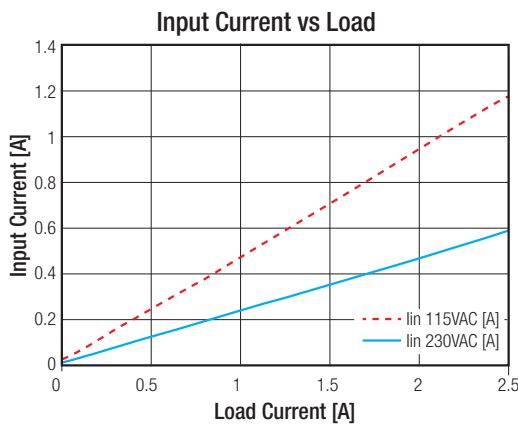
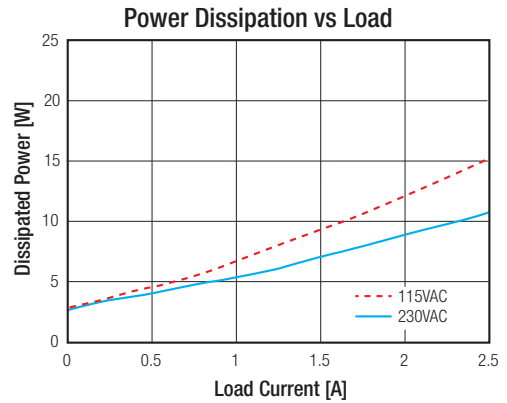
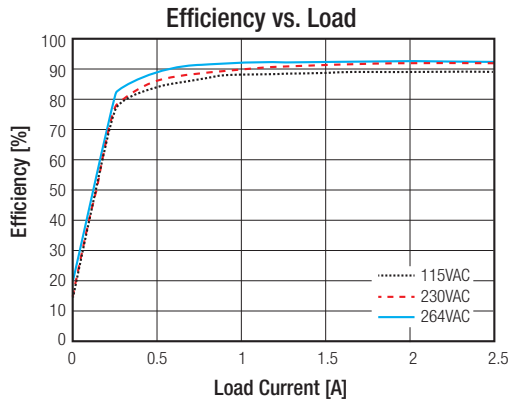

REGULATION		
Parameter	Condition	Value
Output Accuracy		$\pm 0.25\%$ typ. / $\pm 1\%$ max.
Line Regulation		$\pm 0.1\%$ typ. / $\pm 0.5\%$ max.
Load Regulation	0% to 100% load	$\pm 0.25\%$ typ. / $\pm 1.0\%$ max.
Transient Response	100Hz & 1kHz, 50% duty	$\pm 1\%$ typ. / $\pm 5\%$ max.

PROTECTION		
Parameter	Condition	Value
Input Fuse	internal	T5A, slow blow type
Short Circuit Protection (SCP)		Hiccup Mode (current limit)
Over Voltage Protection (OVP)	12Vout	15-18VDC, Hiccup Mode
	24Vout	29-33VDC, Hiccup Mode
	48Vout	58-65VDC, Hiccup Mode
Over Voltage Category (OVC)		OVC II
Over Load Protection (OLP)		Constant power (current limit)
Over Temperature Protection (OTP)		$100\pm 5^\circ\text{C}$ , detect on Heat-sink of power transistor; shut down O/P, auto recovery after temperature goes down
Power OK LED	ON (green) OFF (red) Relay Contact Rating	Vout up to 90% of rated Vout Vout down to 80% of rated Vout Max. 30V/1A or 60V/0.3 or 30VAC/0.3A Resistive Load

continued on next page

### Specifications (measured @ $t_a = 25^\circ\text{C}$ , rated $V_{in}$ , rated load and after warm up)

Isolation Voltage	I/P to O/P I/P to PE O/P to PE	3.0kVAC / 1minute 2.5kVAC / 1minute 0.5kVAC / 1minute
Isolation Resistance		10M $\Omega$ min.
Leakage Current	I/P to O/P I/P to PE, 240VAC 50Hz	0.1mA typ. / 0.25mA max. 1.0mA max.

### Overload Capability

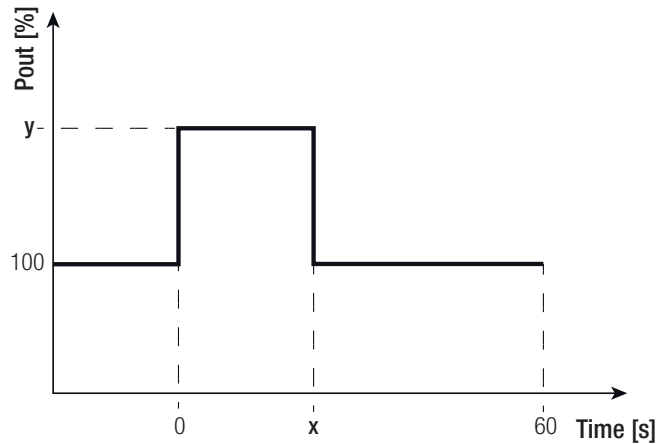

### ENVIRONMENTAL

Parameter	Condition	Value
Operating Temperature Range	with derating	-25°C to +70°C
Temperature Coefficient		$\pm 0.03\%/^\circ\text{C}$
Operating Altitude		3000m
Operating Humidity	non-condensing	20% - 90% RH
IP Rating		IP20
Pollution Degree (PD)		PD2
Shock		10-500Hz 2G, 60min.
Vibration		10G / 11ms, along x,y and z axis
MTBF	MIL-HDBK-217F, full load, 25°C	300 x 10 <sup>3</sup> hours

### Derating Graph

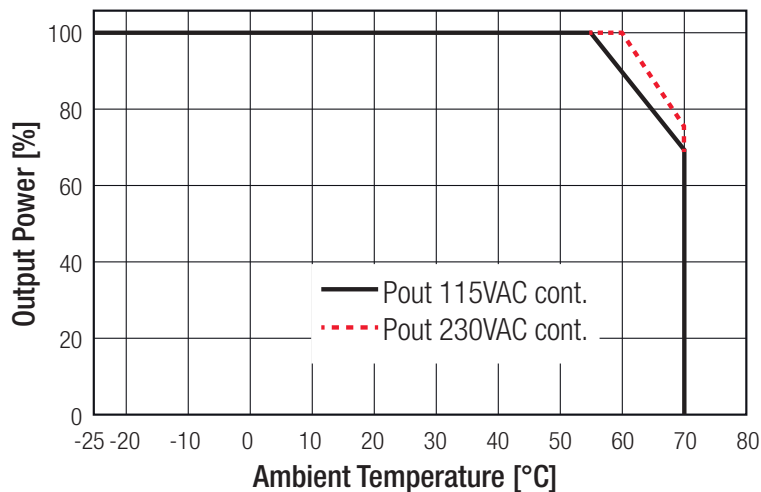

continued on next page

**Specifications (measured @  $t_a = 25^\circ\text{C}$ , rated  $V_{in}$ , rated load and after warm up)**

<b>SAFETY AND CERTIFICATIONS</b>		
<b>Certificate Type</b>	<b>Report / File Number</b>	<b>Standard</b>
Information Technology Equipment, General Requirements for Safety	E224736	UL60950-1, 2nd Edition, 2014 CSA C22.2 No. 60950-1-07, 2nd Edition, 2014
Industrial Control Equipment	E470721	UL508, 17th Edition, 2013 CSA C22.2 No. 107.1-01, 3rd Edition, 2011
Information Technology Equipment - General Requirements for Safety	SA1508106S 001 + SA1508106S 002	IEC60950-1, 2nd Edition 2005, +AM1:2009 + AM2:2013 EN60950-1:2006, + A11:2009 + A1:2010 + A12:2011 + A2:2013
<b>EMC Compliance</b>	<b>Report / Condition</b>	<b>Standard / Criterion</b>
Information technology equipment - Radio disturbance characteristics - Limits and methods of measurement		EN55022, Class B, 2010
Information technology equipment - Immunity characteristics - Limits and methods of measurement		EN55024, Class B, 2010
Limitations on the amount of electromagnetic interference allowed from digital and electronic devices		47 CFR FCC Part 15, Subpart B: 2014
Methods of Measurement of Radio-Noise Emissions from Low-Voltage Electrical and Electronic Equipment in the Range of 9 kHz to 40 GHz		ANSI C63.4: 2014
ESD Electrostatic discharge immunity test	Air $\pm 8\text{kV}$ , Contact $\pm 4\text{kV}$	EN61000-4-2, Criteria B, 2009
Radiated, radio-frequency, electromagnetic field immunity test	3V/m	EN61000-4-3, Criteria A, 2006
Fast Transient and Burst Immunity	AC Power Port: L+N+PE $\pm 1\text{kV}$	EN61000-4-4, Criteria B, 2012
Surge Immunity	AC Power Port L-N $\pm 1\text{kV}$ , L-PE + N-PE $\pm 2\text{kV}$	EN61000-4-5, Criteria B, 2014
Immunity to conducted disturbances, induced by radio-frequency fields	AC Power Port 3V	EN61000-4-6, Criteria A, 2014
Power Magnetic Field Immunity	50Hz, 1A/m	EN61000-4-8, Criteria A, 2010
Voltage Dips and Interruptions	Voltage Dips >95% Voltage Dips 30% Voltage Interruptions >95%	EN61000-4-11, Criteria B, 2004 EN61000-4-11, Criteria C, 2004 EN61000-4-11, Criteria C, 2004
Limits of Harmonic Current Emissions		EN61000-3-2, Criteria A, 2014
Voltage Fluctuations & Flicker		EN61000-3-3, Clause 5: 2013

<b>DIMENSION and PHYSICAL CHARACTERISTICS</b>		
<b>Parameter</b>	<b>Type</b>	<b>Value</b>
Material	Case Cover	Aluminium Nickel plated steel
Package Dimension (LxWxH)	without mounting clip	114.5 x 33.0 x 124.4mm
Package Weight		590g typ.
continued on next page		

Specifications (measured @  $t_a = 25^\circ\text{C}$ , rated  $V_{in}$ , rated load and after warm up)

Dimension Drawing (mm)

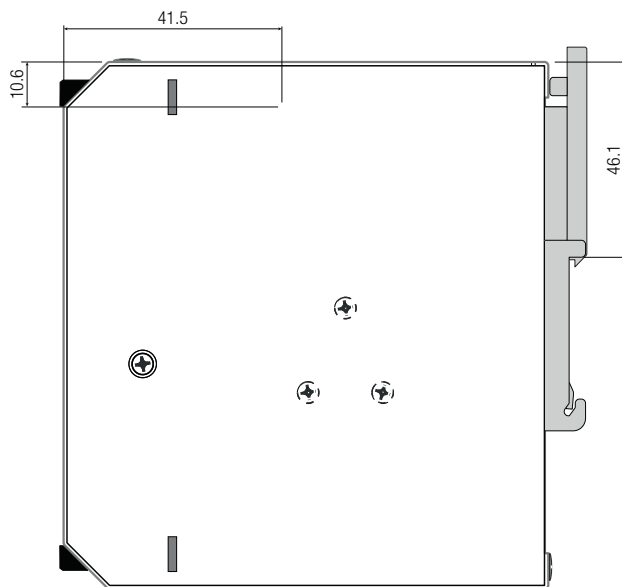
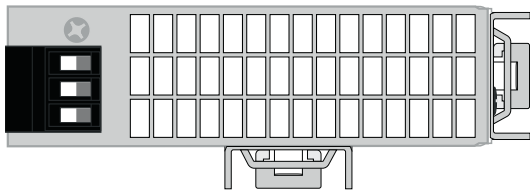
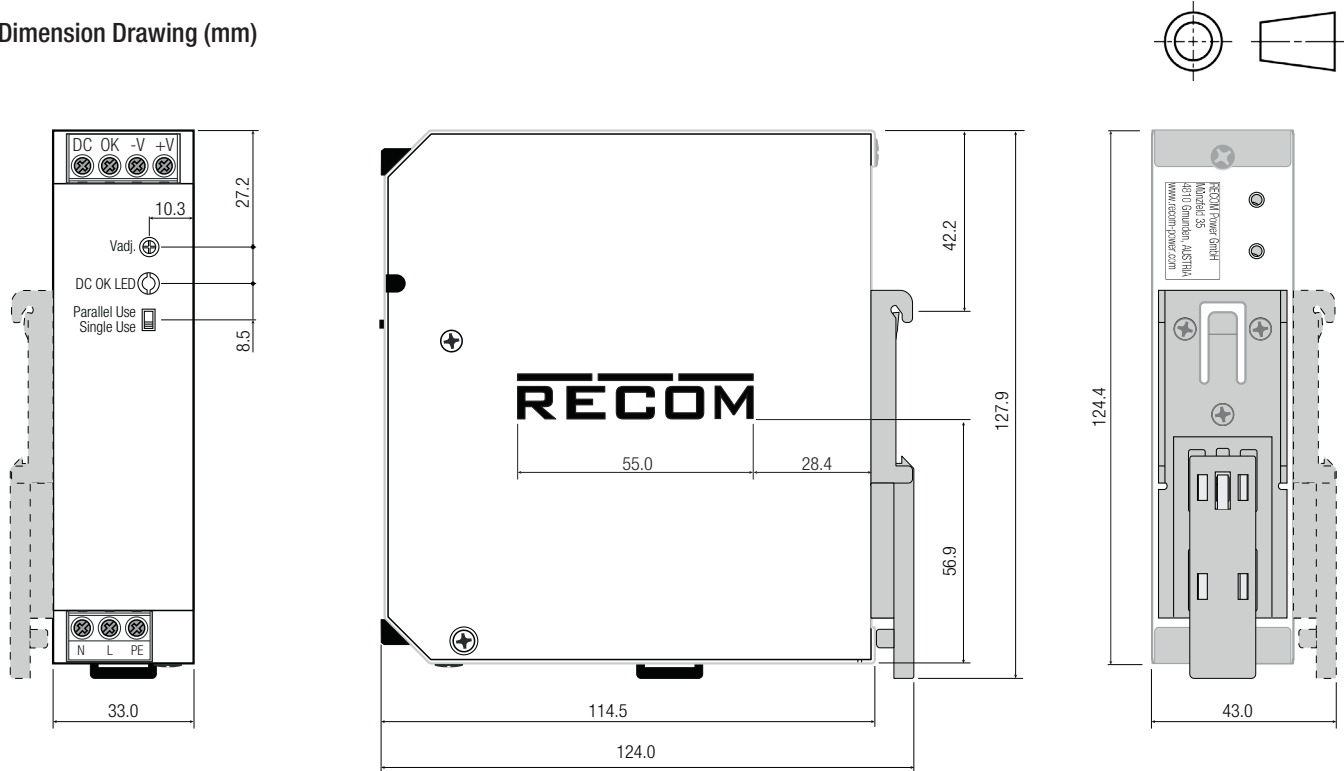

Terminals and Wiring

Type	Screw Connector
Solid Wire	2.5-6mm <sup>2</sup>
Stranded Wire	2.5-4mm <sup>2</sup>
American Wire Gauge (AWG)	AWG10-16
Wire Stripping Length	8mm
Screwdriver (slotted / cross)	3.5mm
Recommended tightening torque	0.5Nm-0.8Nm
Tolerance: X.X ±0.5mm X.XX ±0.25mm	

Specifications (measured @  $t_a = 25^\circ\text{C}$ , rated  $V_{in}$ , rated load and after warm up)

**INSTALLATION and APPLICATION**

**Mounting Instruction**

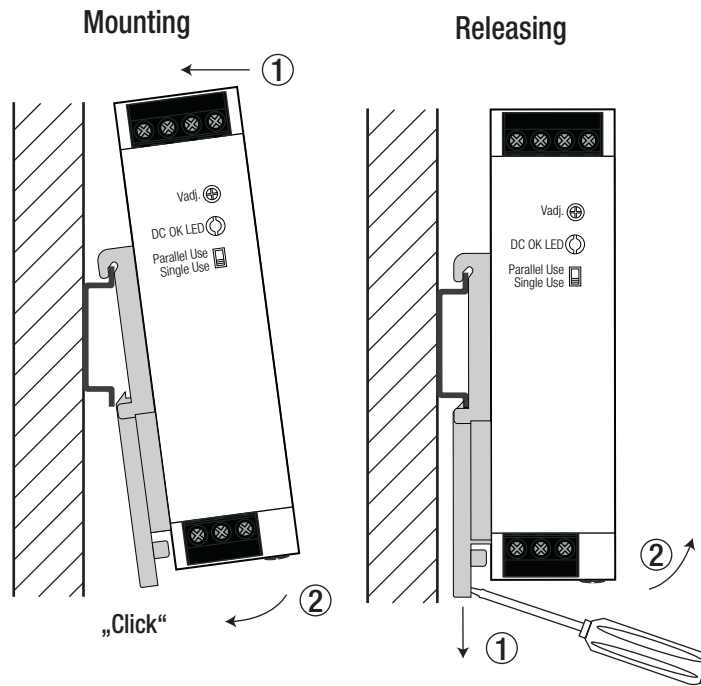

**Mounting Multiple Power Supplies**

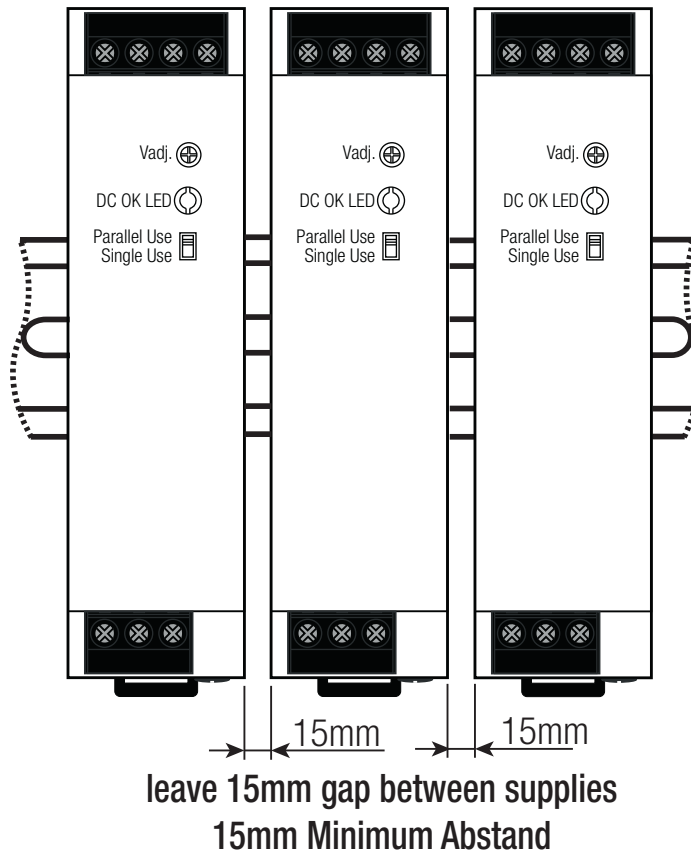

Specifications (measured @  $t_a = 25^\circ\text{C}$ , rated  $V_{in}$ , rated load and after warm up)

**Parallel Operation**

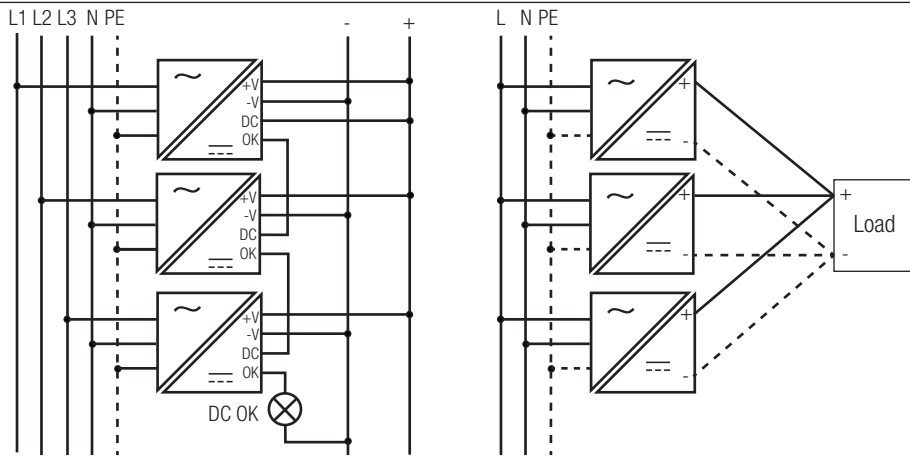

**Single Operation:**

- 1) Make sure that the front panel switch is set to "single Use."
- 2) The output voltage can be increased by trim pot to compensate any cable losses.

**Parallel Operation:**

- 1) Make sure that the front panel switch is set to "single Use" on each power supply.
- 2) Adjust each power supply to the exact same output voltage with same load and cooling conditions.
- 3) Set the front panel switches to "Parallel Use." Use the same wire length for each power supply (star connection) and energize all units at the same time to avoid triggering overload protection.

Derate the maximum output power to 90% of nominal ratings.

For operation with more than three power supplies in parallel or series operation, please contact RECOM technical support for advice.

**Application Circuit**

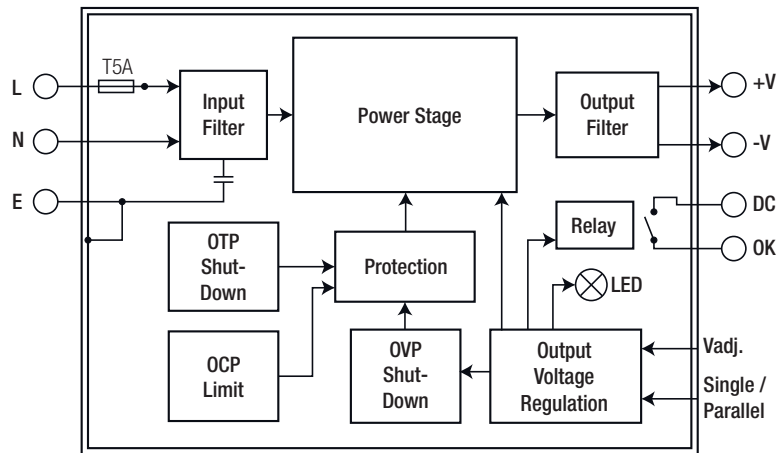

**PACKAGING INFORMATION**

Parameter	Type	Value
Packaging Dimension (LxWxH)	cardboard box	140.0 x 50.0 x 142.0mm
Packaging Quantity	cardboard box	1pcs.
Storage Temperature Range		-40°C to +85°C
Storage Humidity		5% - 95% RH

The product information and specifications are subject to change without prior notice. RECOM products are not authorized for use in safety-critical applications (such as life support) without RECOM's explicit written consent. A safety-critical application is defined as an application where a failure of a RECOM product may reasonably be expected to endanger or cause loss of life, inflict bodily harm or damage property. The buyer shall indemnify and hold harmless RECOM, its affiliated companies and its representatives against any damage claims in connection with the unauthorized use of RECOM products in such safety-critical applications.